

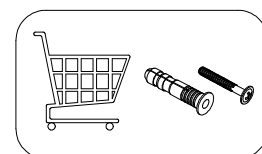

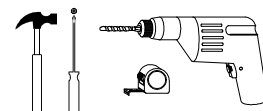

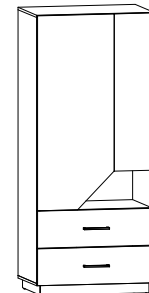





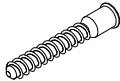

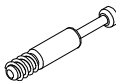

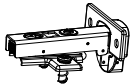

PAX-22

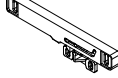
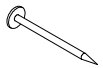
SZAFA 80 2D2S

L-80 H-187 D-57

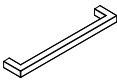
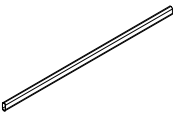
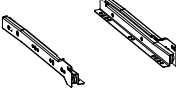

x 16  AKC00019	x 22  AKC00120	x 22  AKC00004	x 14  AKC00029	x 14  AKC00151	x 14  AKC00004
x 5  ZAW00025	x 4  AKC00036	x 2  RUR00002	x 6  NOG00033	x 1  AKC00040	x 2  AKC00153
x 70  AKC00018	x 47  3,5x16 AKC00026	x 4  4x20 AKC00026	x 10  3,5x30 AKC00026	x 4  4x25 AKC00026	x 1  AKC00017

x 2  UCH00058
x 1 L-764 mm  RUR00001
x 2 L-400 mm  MEC00396

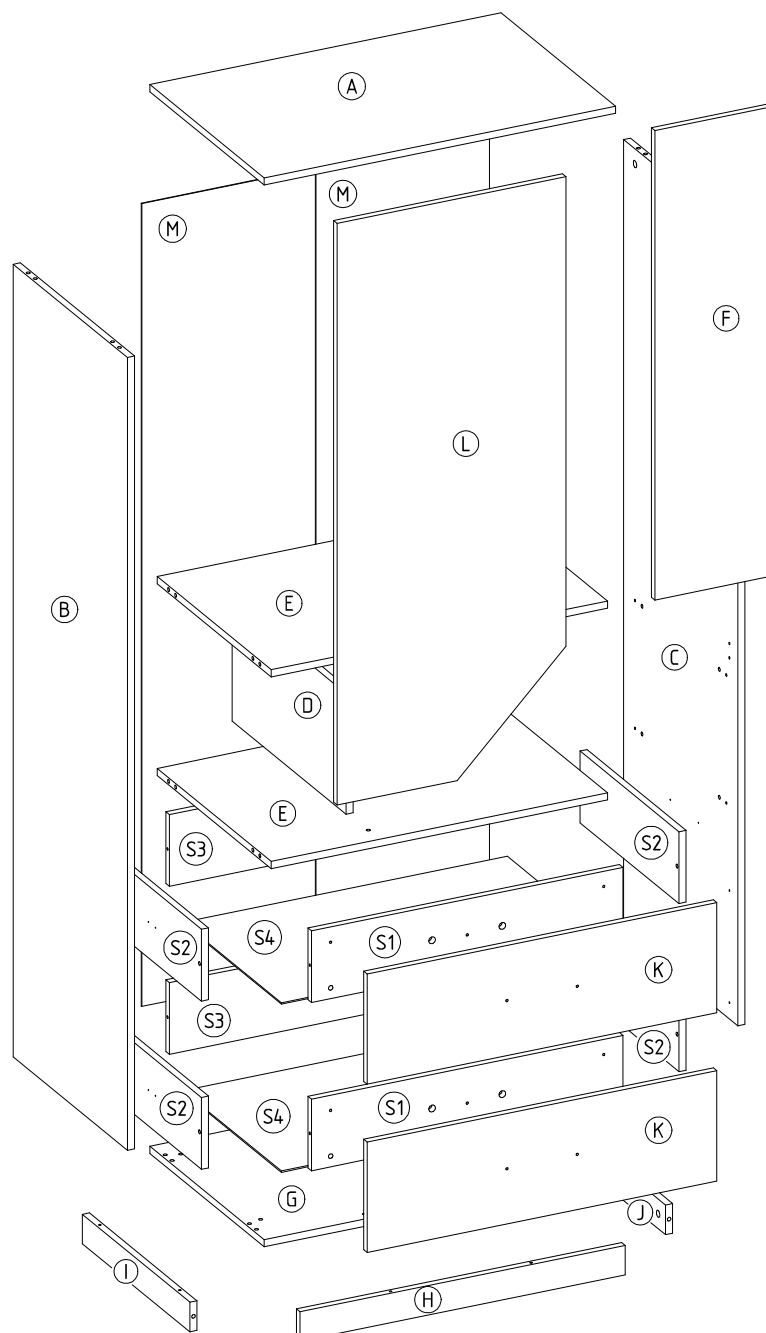

1

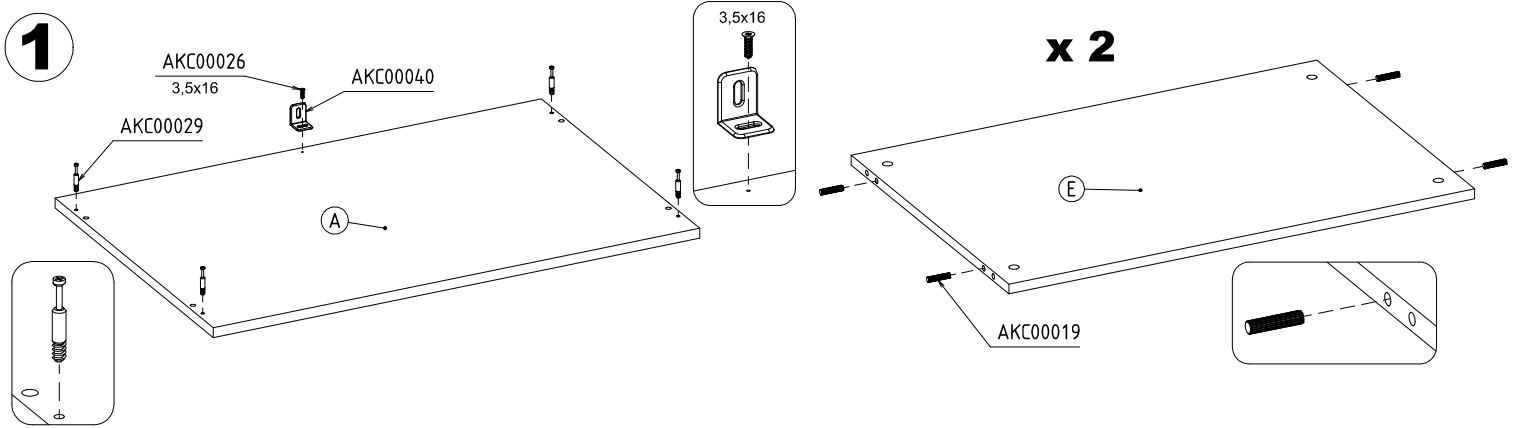

2

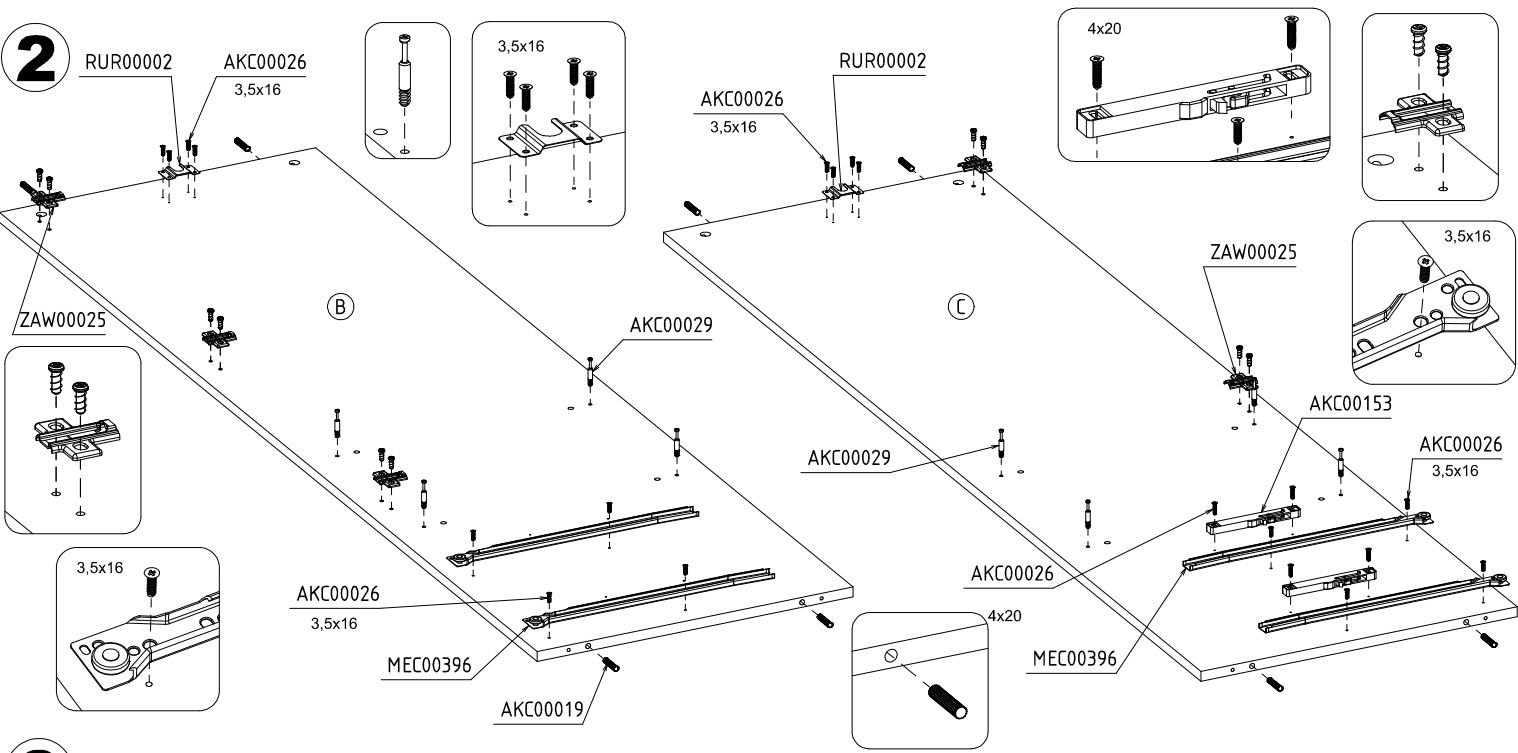

3

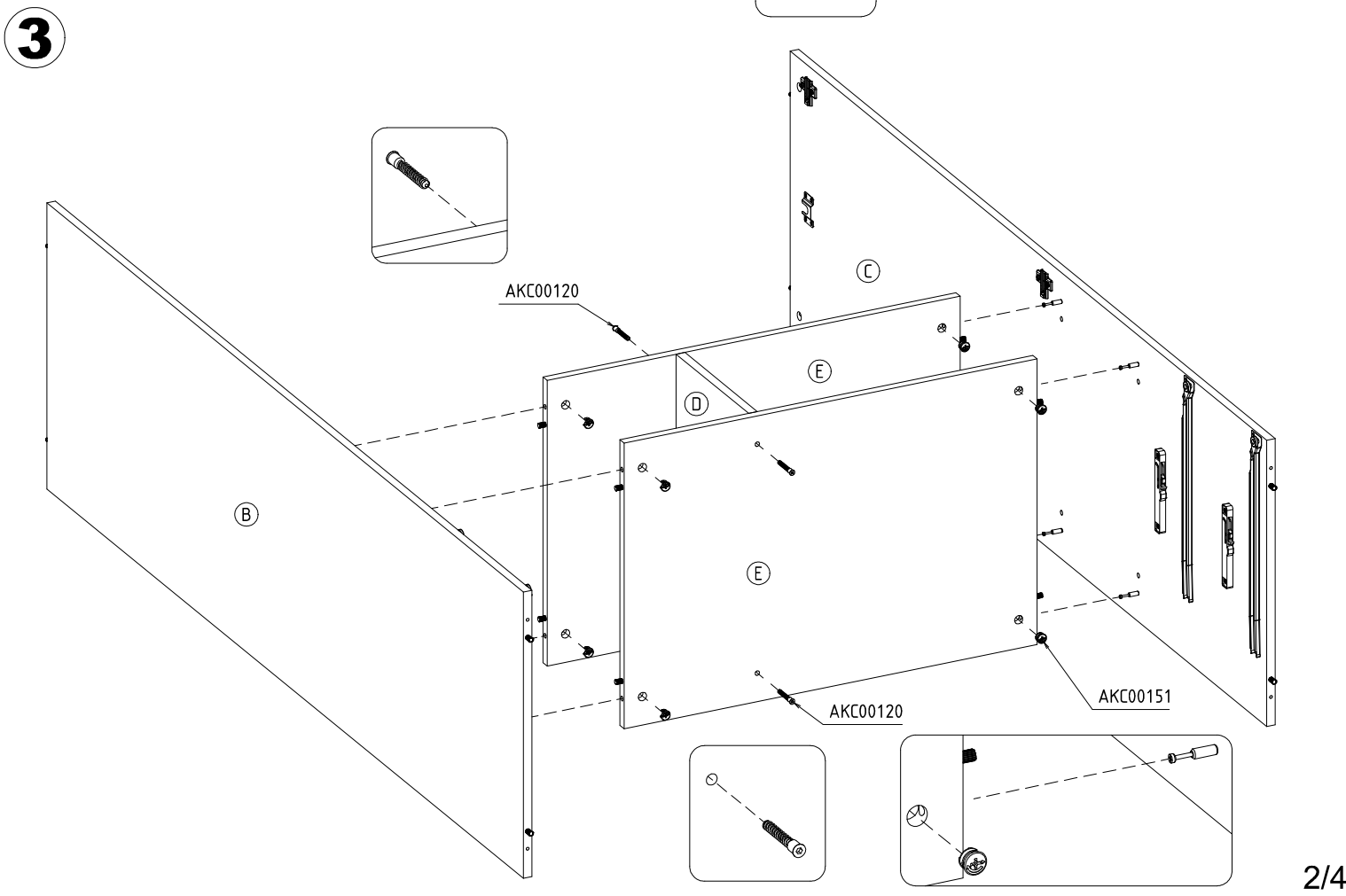

4

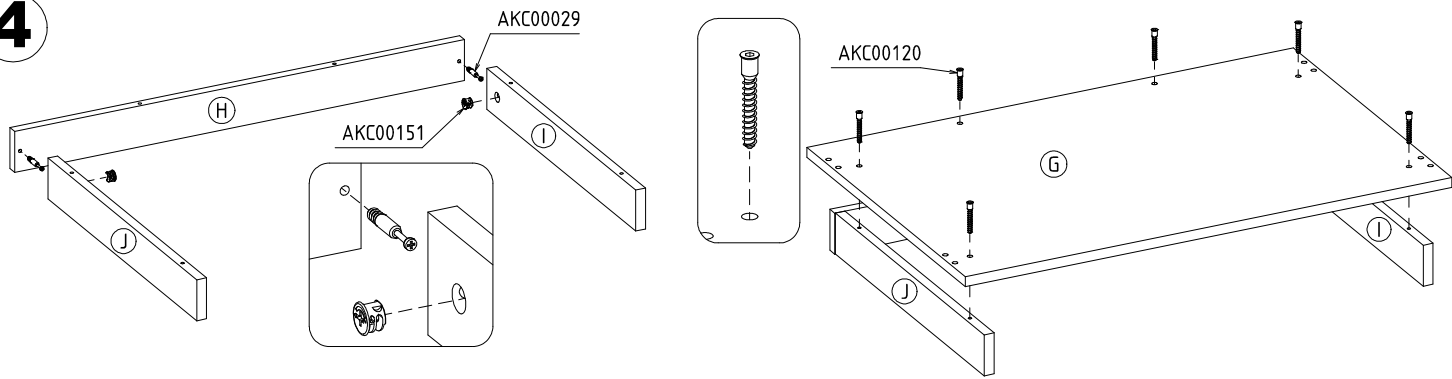

5

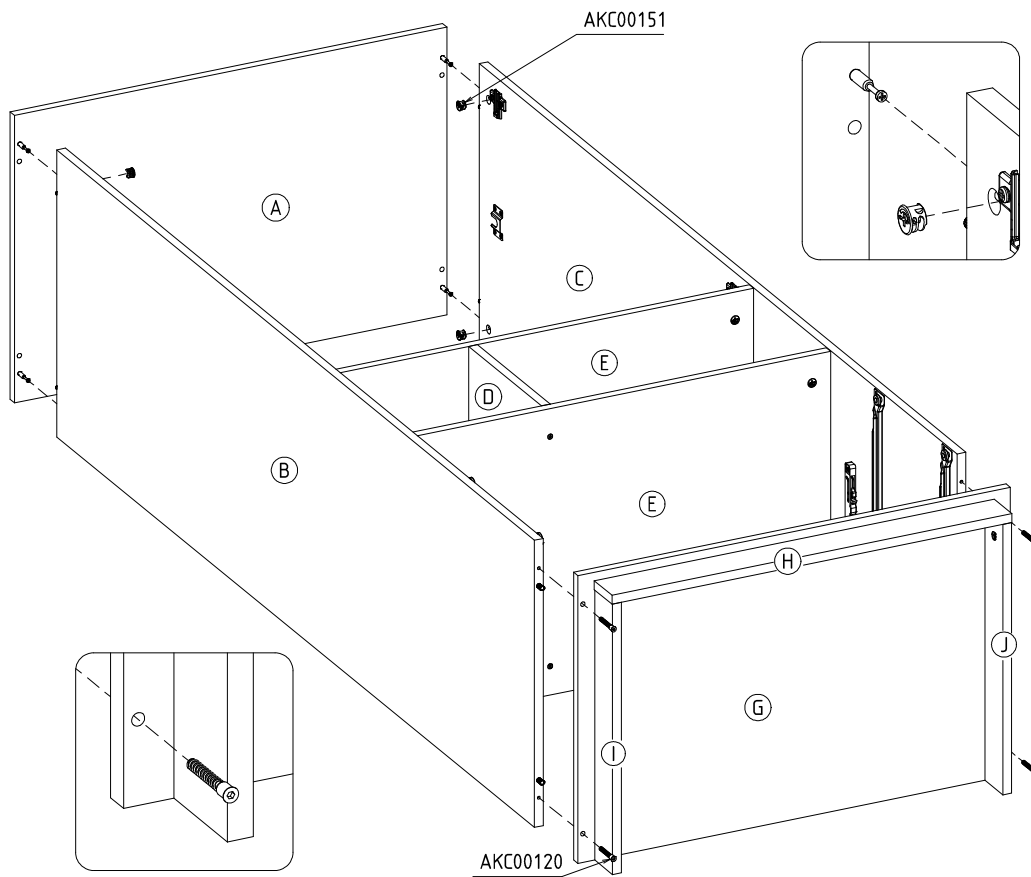

6

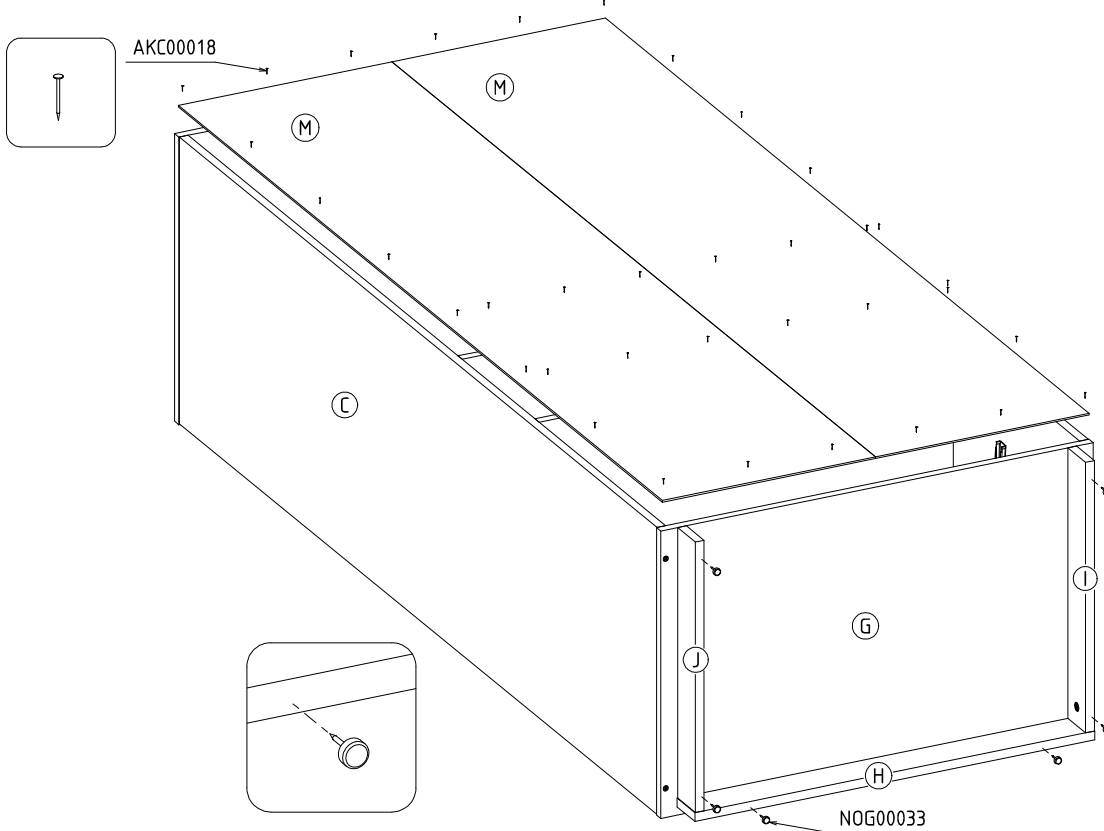

7

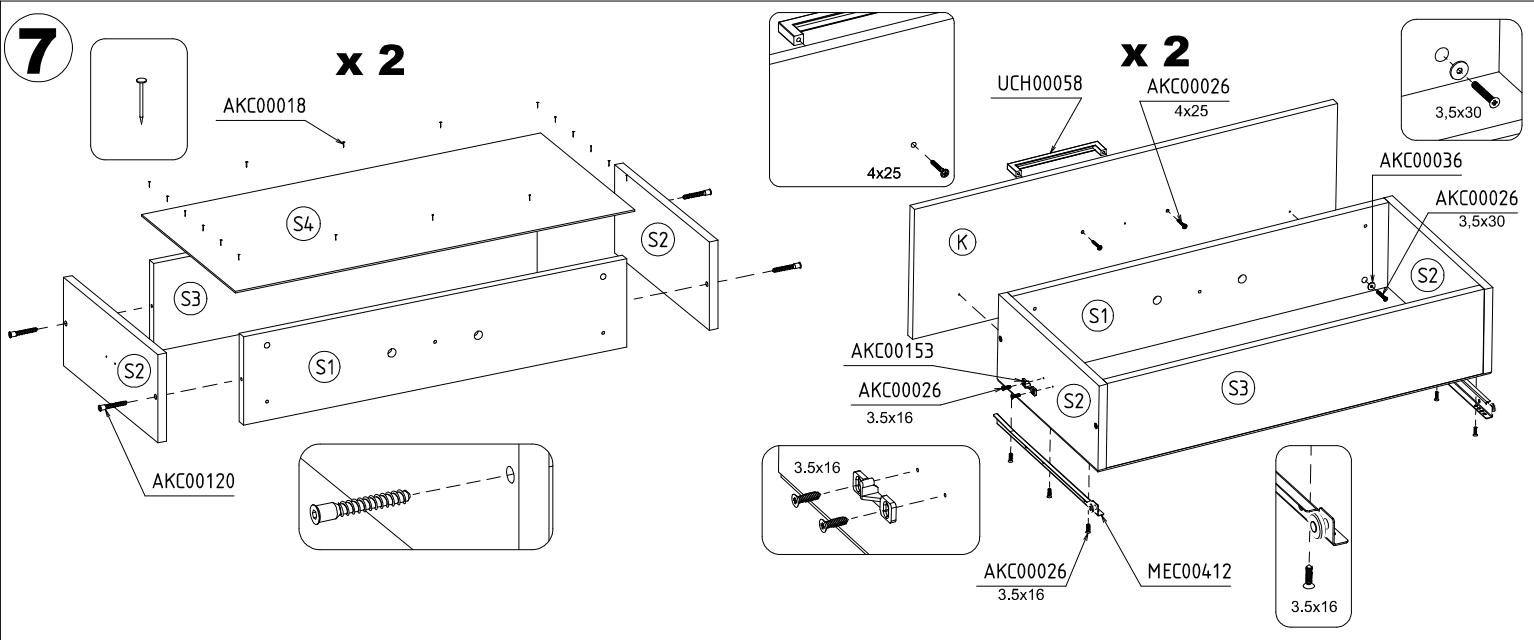

8

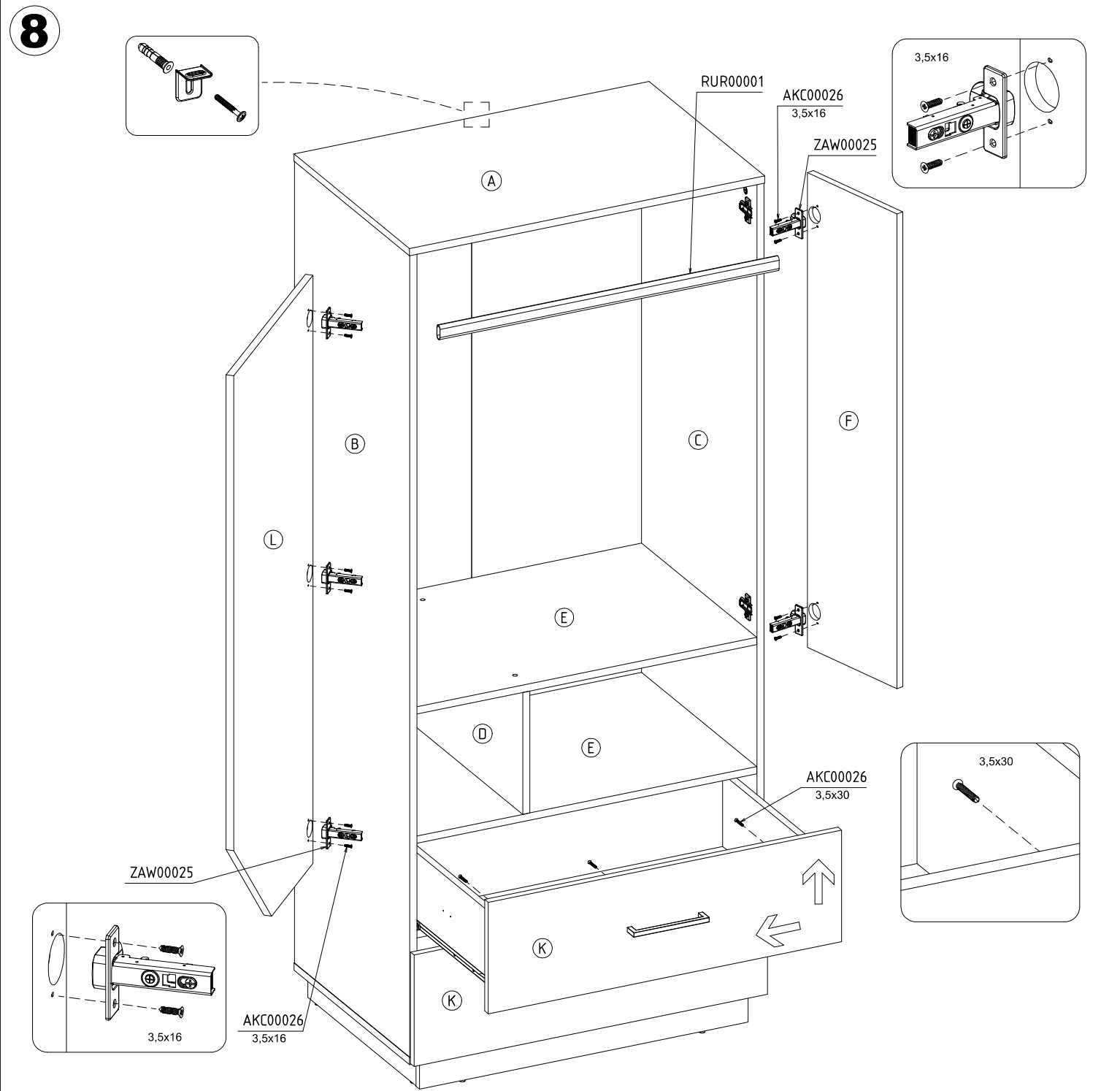

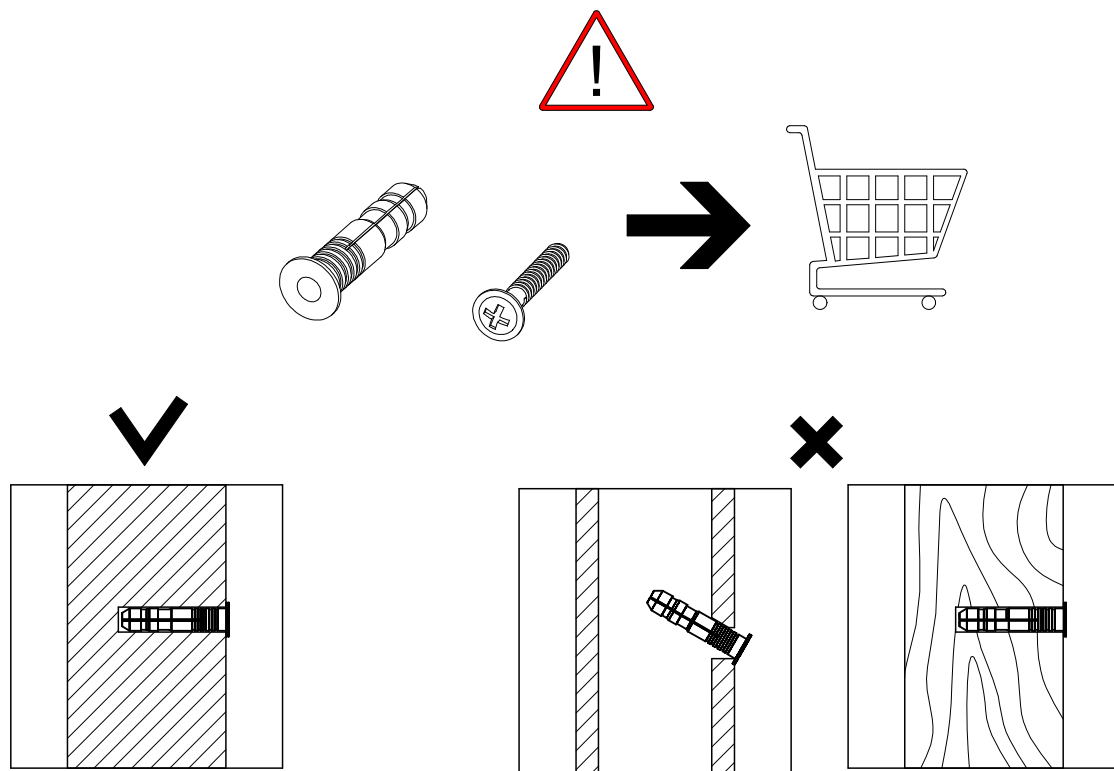

PL-Przed zawieszeniem mebla lub przymocowaniem do ściany (w celu zabezpieczenia przed przewróceniem), sprawdź wcześniej rodzaj i wytrzymałość ściany. Dobierz odpowiednie kołki i wkręty do rodzaju ściany.

EN- Before hanging the furniture or attaching it to the wall (in order to prevent it from tipping over), check the type and strength of the wall beforehand. Select the appropriate plugs and screws for the type of wall..

FR- Avant de suspendre le meuble ou de le fixer au mur (pour éviter qu'il ne bascule), vérifiez au préalable le type et la résistance du mur. Sélectionnez les chevilles et les vis adaptées au type de mur.

DE-Bevor Sie die Möbel aufhängen oder an der Wand befestigen (um ein Umkippen zu verhindern), überprüfen Sie vorher Art und Stärke der Wand. Wählen Sie die entsprechenden Stopfen und Schrauben für den Wandtyp aus.

FI- Ennen kuin ripustat huonekalut tai kiinnität ne seinälle (estäksesi niiden kaatumisen), tarkista etukäteen seinän tyyppi ja lujuus. Valitse sopivat tulpat ja ruuvit seinätyypille.

NL-Voordat u het meubilair ophangt of aan de muur bevestigt (ter bescherming tegen kantelen), controleert u van tevoren het type en de sterkte van de muur. Kies de juiste pinnen en schroeven voor uw muurtype.